



2011 Rotationally-Molded Spa Owner's Manual



Customer Service 1•800•787•6649

email: support@strongspas.com

READ AND FOLLOW ALL INSTRUCTIONS



Unit is IPX5 Compliant

*Congratulations on your purchase of a spa
manufactured by Durasport Spas™.*

Your new spa will bring you years of
enjoyment and relaxation.

Please take the time to familiarize yourself with the
safety precautions, and operational procedures,
as well as the routine water maintenance and cleaning
so that your spa will provide a
healthy environment for all your bathers.

Enjoy!

Important Safety Instructions and Warnings	4
Prepare for Your New Spa	
Plan the Best Location	6
Prepare a Good Foundation	6
120 Volt Electrical Operation (North America)	7
Conversion from 120V to 240 Volt (North America).....	8
240 Volt Electrical Installation (North America)	10
240 Volt 60hZ Wiring Diagram (North America)	11
230 Volt 50hZ Wiring Diagram (Europe).....	12
Operating Your Spa	
Filling and Starting Up Your Spa	13
Priming the Pump	14
Topside Control Panel (VS and GS Series)	15
Control Pack Codes (VS and GS Series).....	16
Personalized Settings	
Jets, Air Controls, Diverters, Remotes, Waterfalls	18
LED Lighting	18
Electrical Power Efficiency	18
Testing and Adjusting Spa Water	
Water Maintenance Overview	19
Sanitation, Ozonator, Filtration, Chemical Balance, Testing Methods	19
Balancing Your Spa's Water Chemistry (Alkalinity, Calcium Hardness, pH)	20
Chlorine and Bromine Sanitation Overviews	20
Chemical Safety	21
Filter Cleaning	22
Starting the Spa with Fresh Water.....	22
Maintenance Schedule	23
Troubleshooting	
Water Quality Problems	25
Operational Problems	26
Care and Maintenance	
Draining Your Spa	29
Vacation Care	29
Jet Removal and Replacement	29
Cleaning Resin Spa Surfaces	29
Winterizing.....	30
Parts Catalog.....	32
Warranty Registration	47

CONTACT INFORMATION

For customer service, please contact your authorized dealer immediately.
If you need additional information and/or assistance, call 1-800-787-6649

Durasport™ Spas

3204 Point Township Drive, Northumberland, PA 17857

*Durasport™ Spas reserves the right to make product modifications and enhancements without notice.
Specifications and dimensions are approximate and for reference only.*

Important Safety Instructions and Warnings

READ AND FOLLOW ALL INSTRUCTIONS

To reduce the risk of injury, do not permit children to use this product unless they are closely supervised at all times.



Warning: Children should not use spas or hot tubs without adult supervision.

Avertissement: Ne pas laisser les enfants utiliser une cuve de relaxation sans surveillance.



Warning: Do not use spas or hot tubs unless all suction guards are installed to prevent body and hair entrapment.

Avertissement: Pour éviter que les cheveux ou une partie du corps puissent être aspirés, ne pas utiliser une cuve de relaxation si les grilles de prise d'aspiration ne sont pas poutes en place.



Warning: People using medications and/or having an adverse medical history should consult a physician before using spa or hot tub.

Avertissement: Les personnes qui prennent des médicaments ou ont des problèmes de santé devraient consulter un médecin avant d'utiliser une cuve de relaxation.



Warning: People with infectious diseases should not use a spa or hot tub.
Avertissement: les personnes atteintes de maladies infectieuses ne devraient pas utiliser une cuve de relaxation.



Warning: To avoid injury, exercise care when entering or exiting the spa or hot tub.

Avertissement: Pour éviter des blessures, user de prudence en entrant dans une cuve de relaxation en sortant.



Warning: Do not use drugs or alcohol before or during the use of a spa or hot tub, to avoid unconsciousness and possible drowning.

Avertissement: Pour éviter l'évanouissement et la noyade éventuelle, ne prendre ni drogue ni alcool avant d'utiliser une cuve de relaxation ni quand on s'y trouve.



Warning: Pregnant or possibly pregnant women should consult a physician before using a spa or hot tub.

Avertissement: Les femmes enceintes, que leur grossesse soit confirmée ou non, devraient consulter un médecin avant d'utiliser une.



Warning: Water temperature in excess of 38°C may be injurious to your health.

Avertissement: Il peut être dangereux pour la santé de se plonger dans de l'eau à plus de 38°C.



Warning: Before entering the spa or hot tub, measure the water temperature with an accurate thermometer.

Avertissement: Avant d'utiliser une cuve de relaxation mesurer la température de l'eau à l'aide d'un thermomètre précis.



Warning: Do not use a spa or hot tub immediately following strenuous exercise.

Avertissement: Ne pas utiliser une cuve de relaxation immédiatement après un exercice fatigant.

SAVE THESE INSTRUCTIONS

READ AND FOLLOW ALL INSTRUCTIONS

To reduce the risk of injury, do not permit children to use this product unless they are closely supervised at all times.



Warning: Prolonged immersion in a spa or hot tub may be injurious to your health.

Avertissement: L'utilisation prolongée d'une cuve de relaxation peut être dangereuse pour la santé.



Warning: Do not permit or use electric appliances (such as a light, telephone, radio or television) within 1.5 meters of spa or hot tub.

Avertissement: Ne pas placer d'appareil électrique (luminaire, téléphone, radio, téléviseur, etc.) à moins de 1.5 meters de cette cuve de relaxation.



Caution: Maintain water chemistry in accordance with the manufacturer's instructions.

Attention: La teneur de l'eau en matières dissoutes doit être conforme aux directives du fabricant.



HYPERTHERMIA

Hyperthermia occurs when the internal temperature of the body reaches a level several degrees above the normal body temperature of 37°C. The symptoms of hyperthermia include:

- 1) Unawareness of impending hazard;
- 2) Failure to perceive heat;
- 3) Failure to recognize the need to exit the spa or hot tub;
- 4) Physical inability to exit the spa or hot tub;
- 5) Fetal damage in pregnant women; and
- 6) Unconsciousness and resulting in the danger of drowning.



Warning: The use of alcohol or drugs can greatly increase the risk of fatal hyperthermia in hot tubs or spas.

Avertissement: La consommation d'alcool ou de drogue augmente considérablement.

SAVE THESE INSTRUCTIONS

Prepare for Your New Spa

Prepare for Your New Spa

Most cities and counties require permits for exterior construction and electrical circuits. In addition, some communities have codes requiring residential barriers such as fencing and/or self-closing gates on property to prevent unsupervised access to the property by children. Your local code enforcement officer can provide information on which permits may be required and how to obtain them prior to the delivery of your spa.

Prepare a Good Foundation

Damage caused by an inadequate or improper foundation is not covered by the warranty. The spa owner is responsible for providing a proper foundation. Place the spa on a solid, level foundation. If you are installing the spa indoors (not recommended), pay close attention to the flooring beneath it. Choose flooring that will not be damaged or stained. If you are installing your spa on an elevated wood deck or other structure, consult a structural engineer or a contractor to ensure the structure will support the weight of 150 pounds per square foot.

Plan the Best Location



SAFETY FIRST

Do not place your spa within 10 feet (3 m) of overhead power lines.

Do not use in warm, damp, equable climates.

IMPORTANT: Durasport® Spas Warranty is void if the spa is moved to any location that is not the original 'Ship To' address.

Consider Spa Use

How you intend to use your spa will help you determine where you should position it. For example, will you use your spa for recreational or therapeutic purposes? If your spa is mainly used for family recreation, be sure to leave plenty of room around it for activity. If you will use it for relaxation and therapy, you will probably want to create a specific mood around it.

Climate, Privacy and View

Place the spa near a house entry if you live in a snowy or rainy environment so you have a place to comfortably change clothes. Consider seasonal changes, too. Bare trees don't provide much privacy. And don't forget to think of your neighbors' view of you, and your view of your neighbors.

Keep Your Spa Clean

In planning your spa's location, consider a location where there is a clean path to and from the house. Use a mat at the spa's entrance to encourage bathers to clean their feet before entering your spa.

Allow for Service Access

If you are installing your spa near a wall or with any type of structure on the outside, such as a gazebo, remember to allow access for service.



120 Volt Electrical Installation

(North America 60hZ)

Always follow applicable local, state and federal codes and guidelines.

- Use a dedicated electrical line with a 15A breaker.
- Cord-and-plug connections may not use a cord longer than 15 feet (4.6 m) and must be plugged into a dedicated 15A GFCI connection (NEC 680.42(A))
- Do not use extension cords!
- Always use a weatherproof-covered receptacle.
- Receptacle shall be located not less than 5 feet (1.5 m) from and not exceeding 10 feet (3.0 m) from the inside wall of the spa. (NEC 680.43(A))



DO NOT USE A GFCI OUTLET with a GFCI CORD!



- Do not bury the power cord. If your cord becomes damaged, replace it before next usage.
- All 120V spas use a GFCI cord and plug as shown.
- Test the GFCI plug prior to first use and periodically when the spa is powered. To test the GFCI plug version, follow these instructions. (Spa should already be plugged in and operational.)

1. Press the TEST button on the GFCI. The GFCI will trip and the spa will stop operating.
2. Press the RESET button on the GFCI. The GFCI will reset and the spa will turn back on.

The spa is now safe to use.

- If the GFCI trips while the spa is in use, press the RESET button. If the GFCI does not reset, unplug the spa and call your local Durasport™ Spas dealer for service. **DO NOT USE THE SPA!**

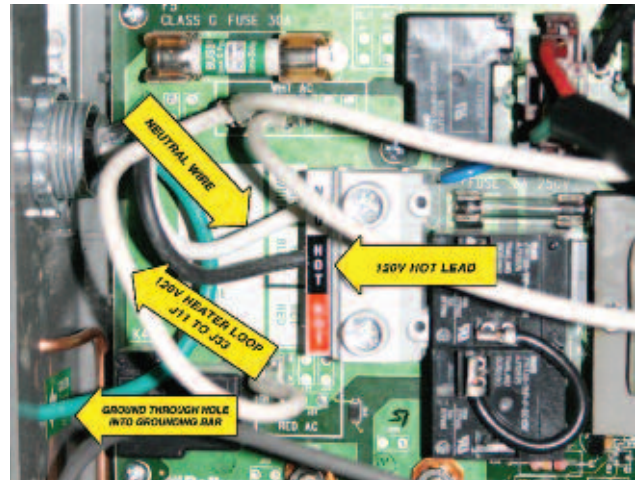

120V

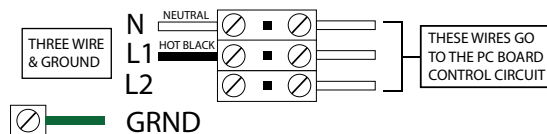

IF USING THE STANDARD 120V SERVICE, YOU MUST USE A DEDICATED LINE, WHICH MEANS THAT THERE CANNOT BE ANY OTHER HOUSEHOLD ITEMS CONNECTED TO THE CIRCUIT OR OUTLET AT ALL! HAVING ANY OTHER ELECTRICAL APPLIANCES AT ALL ON THIS CIRCUIT WHILE THE SPA IS RUNNING WILL TRIP THE BREAKER IMMEDIATELY. DO NOT USE ANY TYPE OF EXTENSION CORDS BETWEEN THE SPA AND THE WALL OUTLET, THIS WILL ALSO CAUSE THE BREAKER TO TRIP AND CAN BE A POTENTIAL FIRE HAZARD.

Prepare for Your New Spa

120V to 240V Conversion

(North America 60hZ)

Some spa owners choose to have their spa converted from 120V operation to 240V operation for greater energy efficiency.



WARNING: The electrical circuit must be installed by a licensed electrical contractor and approved by a local building or electrical inspector.

Failure to comply with state and local codes may result in fire or personal injury and will be the sole responsibility of the spa owner.

The steps to converting your spa from 120V to 240V operation are shown below and must be completed by a licensed electrician.

Power supply installation must include a properly rated GFCI circuit breaker. The circuit must be dedicated and should not be shared with any other appliances. It should be labeled and easily accessible to users. The power supply must be hard wired into the power pack. A hole may be drilled through the resin cabinet near the electrical pack to accommodate wiring. Foam insulation may be sprayed around the hole to fill any gaps between the cabinet and the wiring.



Step 1.
Disconnect jumper from J11.

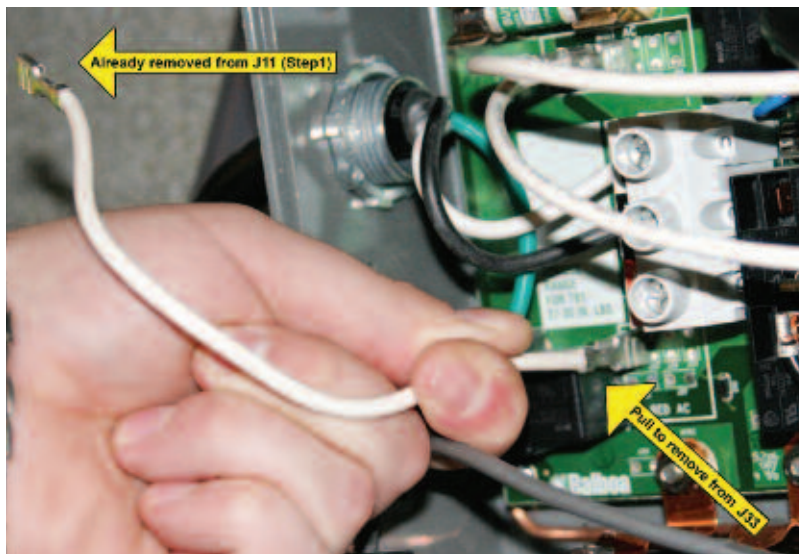

Step 2.
Disconnect other end of same jumper from J33.

DO NOT DISCONNECT ANY OTHER JUMPERS!

Prepare for Your New Spa

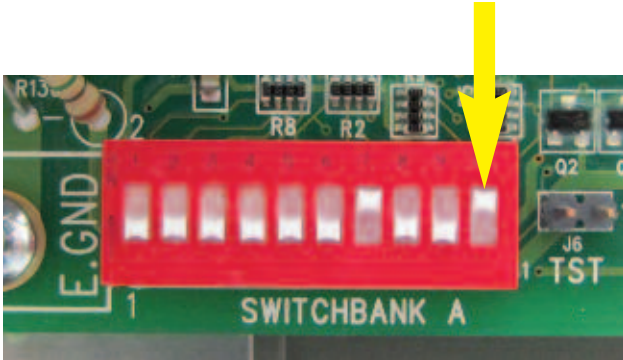

Step 3.

Turn Dipswitch #10 off (down).

To run at 240V, dipswitch #7 should be in the on position.

To run at 120V, dip switches #7 & 10 are the only ones that should be in the ON position. Adjusting any other dip switches will render the spa inoperable and may cause permanent damage. This also voids all warranties.

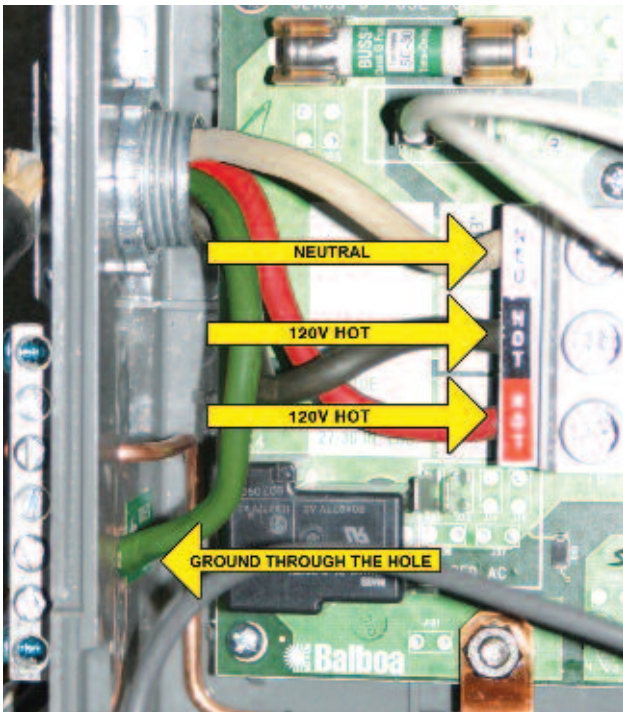

Your 240V wiring should look like this. See Wiring Diagram on page 11 for further information.

If wiring appears differently, **DO NOT** power your spa! Consult a certified electrician.

PLEASE CHECK YOUR LOCAL BUILDING CODES AND ONLY USE A CERTIFIED ELECTRICIAN TO INSTALL ANY ELECTRICAL COMPONENTS TO YOUR SPA.

Prepare for Your New Spa

240 Volt Electrical Installation

(North America 60hZ)



WARNING: The electrical circuit must be installed by a licensed electrical contractor and approved by a local building or electrical inspector.

Failure to comply with state and local codes may result in fire or personal injury and will be the sole responsibility of the spa owner.

- All 240V spas must be permanently hardwired to the power supply. See US wiring diagram on page 11, European wiring diagram on page 12.
- Spas must be wired using this procedure. Any variance from these instructions will void your warranty and may result in serious injury.
- When installed in the United States, the electrical wiring of this spa must meet the requirements of National Electric Code, ANSI/NFPA 70-2008 and any applicable local, state, and federal codes.

GFCI and Wiring Requirements

- The power supplied to the spa must be on a dedicated GFCI protected circuit as required by ANSI/NFPA 70 with no other appliances or lights sharing the power.
- Use copper wire with THHN insulation. Do not use aluminum wire.
- Use the table on this page to determine your

GFCI and wiring requirements.

- When NEC requires the use of wires larger than #6 AWG, install a junction box near the spa and use #6 AWG wire between the junction box and the spa.
- Wire runs over 85 feet must increase wire gauge to the next lower number.

Testing the GFCI Breaker

Test the GFCI breaker prior to first use and periodically when the spa is powered. To test the GFCI breaker follow these instructions

1. With spa operating, press the TEST button on the GFCI. The GFCI will trip and the spa will shut off.
2. Reset the GFCI breaker by switching the breaker to the full OFF position, wait a moment, then turn the breaker back on. The spa should have power.

Warning: Never set a spa to run on high power without installing a properly rated GFCI.

Locate Electrical Pack Part Number and Model Number

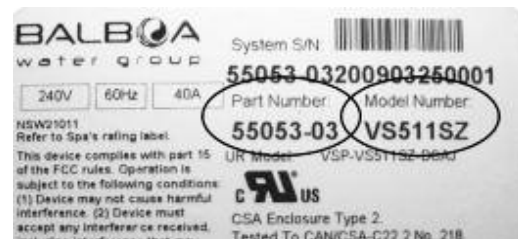

Locate Dip Switch panel

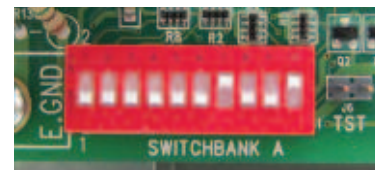

Balboa Pack Model No. and Part No.	Usage Description and Settings	GFCI Required	Wire(s) Required
Model No. VS501Z Part No. 54379-03	1 pump spa (Pump on hi + heat) Dip switch #7 is ON	240V 50 AMP	#6 AWG Copper
Model No. GS500 Part No. 54520	1 pump European Spa Dip switches #2, 3, 6, 7, 8, 10 are ON	230V 20 AMP	#6 AWG Copper

GFCI Wiring Diagram (North America 60Hz)

240V

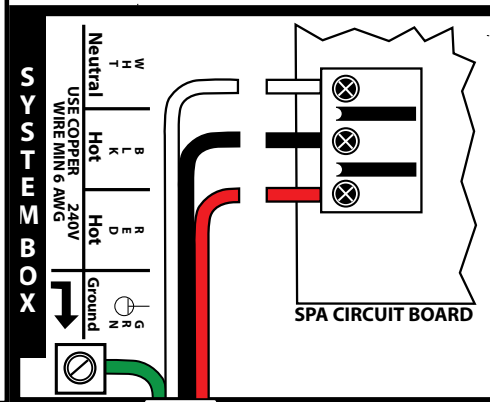
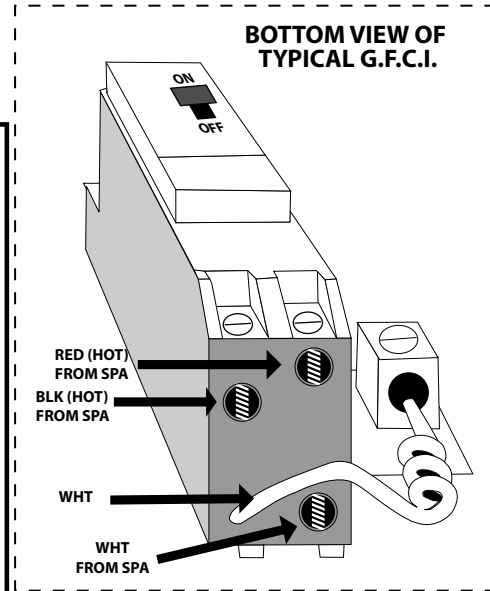
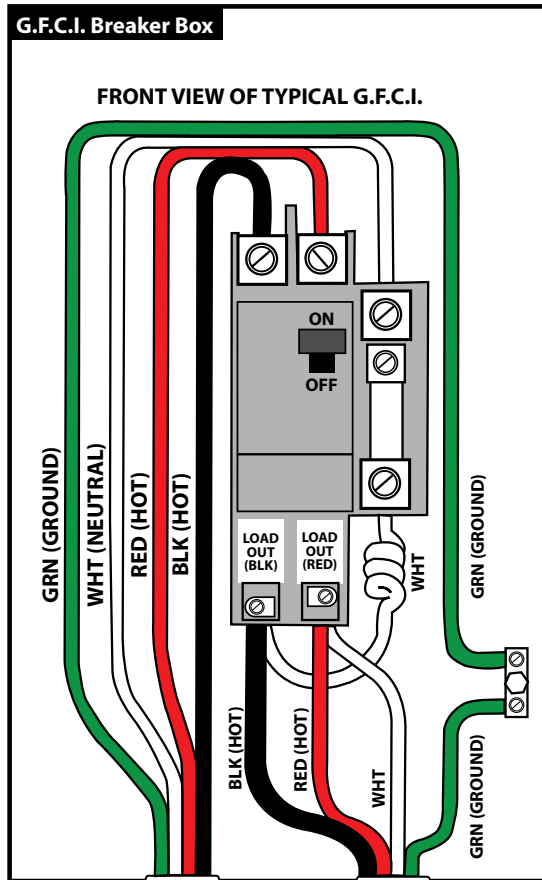
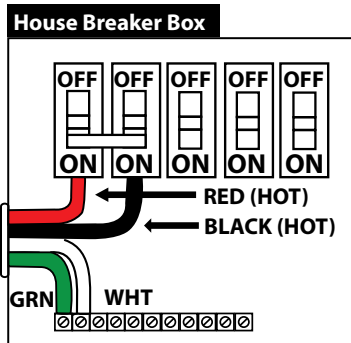
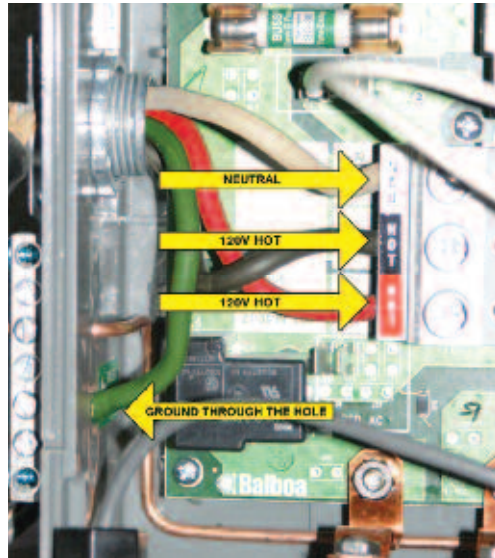
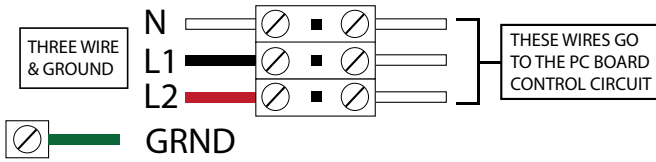

GFCI Wiring Diagram (European 230V 50hZ) Systems with PCB Rev B Only

Note: A residual current device with a tripping current rated not more than 30 mA has to be installed in addition to local requirement.

Protective device for power connection must be on all phase conductors based on local requirements.

AS MANUFACTURED

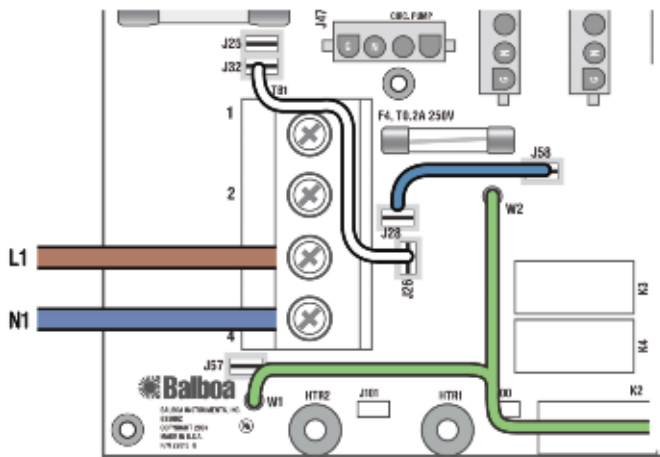

Single Service, TN and TT Electrical Systems

**(1 x 16 Amp or 1 x 32 Amp)
3 Wires (1 Line + 1 Neutral + 1 Protective Earth)**

Protective Earth wire 6mm² minimum (Green/Yellow) must be connected to system ground terminal as marked.

This option is configured and shipped as the default.

All equipment (pumps, blower, and heater) runs on service line L1.

Systems using only 1 DIP switch (A10) for heat disable:

- For 1 x 16 Amp Service: DIP Switch A10 must be ON.
- For 1 x 32 Amp Service: Set DIP Switch A10 such that total system amperage draw never exceeds rated service input.

Systems using multiple DIP switches for heat disable:

- Refer to Switchbank settings on inside cover of pack.

Note: A residual current device with a tripping current rated not more than 30 mA has to be installed in addition to local requirement.

Protective device for power connection must be on all phase conductors based on local requirements.

OPTIONAL

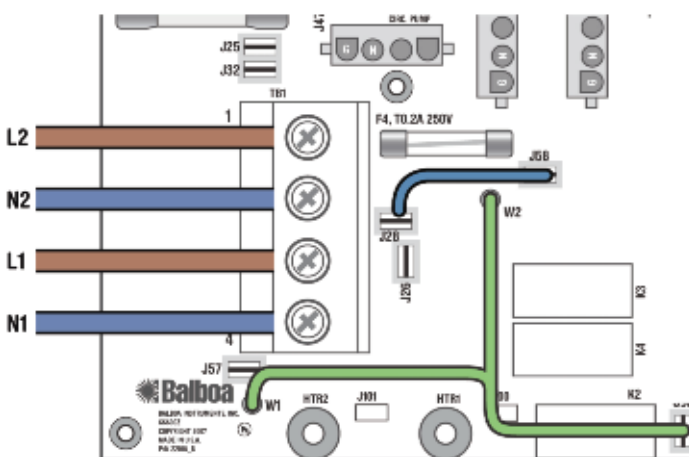

Dual Service, TN and TT Electrical Systems

**(2 x 16 Amp)
5 Wires (2 Lines + 2 Neutrals + 1 Protective Earth)**

Protective Earth wire 6mm² minimum (Green/Yellow) must be connected to system ground terminal as marked.

The heater runs on service line L1, while all other equipment, such as pumps and blowers, run on service line L2.

Completely remove the white wire from J26 and J32.
Note: J32 and J25 are electrically identical. The white wire may be attached to either terminal before removal.

Systems using only 1 DIP switch (A10) for heat disable:

- DIP Switch A10 must be OFF.

Systems using multiple DIP switches for heat disable:

- Refer to Switchbank settings on inside cover of pack.

Filling & Starting Spa

1. Place spa on an approved surface. For North American installation, plug your spa's GFCI cord into a 120V/15A weatherproof outlet or have it properly hardwired to run on 240V by a licensed electrician. For European installation, see previous page.
2. Open access door OR remove exterior spa panels by prying off panel plugs with a flathead screwdriver and removing screws with a Phillips head screwdriver.

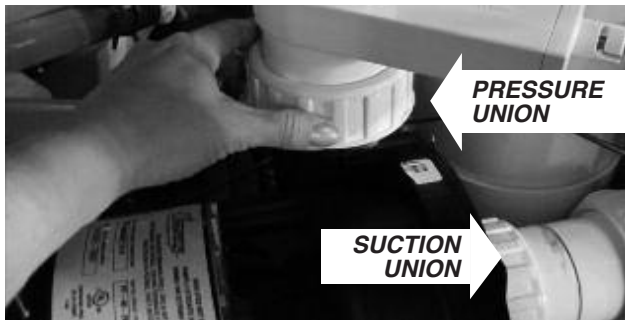

3. Make sure white plumbing unions are secure and did not loosen during shipping. There will be 4 unions. Hand-tighten any loose unions.



4. Open all gate valves in the equipment area. Before operation, these valves must be in the UP/OPEN position and have plastic clips inserted. Never run the spa with the gate valves closed or without water circulating for any period of time.



5. Remove the filter and filter plug (and weir and basket, if equipped) from filter chamber. *Photos may vary from your particular spa model.*



6. Place a garden hose in the filter chamber and fill your spa with regular tap water to 2" higher than the highest jet.

Do not fill your spa with soft water. It is difficult to maintain proper water chemistry with soft water. Also, the water may foam, which will eventually harm the finish of the spa and void your warranty.

7. If you have an automatic bromine generator, turn it off.
8. Once the water is at the correct level and air is bled, turn on the power at the GFCI breaker.

Note: When the power is turned on, the controls will perform a diagnostic check for a few minutes. When complete, the spa will automatically operate at filter speed and continue heating until water reaches 100°F.

9. If water does not flow from jets when the pump is running, there could be an air pocket. See next page, *Priming the Pump*, for methods of removing air pockets from the pump(s)
10. Install the filter plug and filter (and weir and basket, if equipped) into the filter chamber.

For Replacement Filters go to:
www.strongspasretail.com

Priming the Pump

Sometimes air can become trapped in the pump while filling the spa. You will know this has happened when after you have filled and started the spa, the pump does not function. You will hear the pump operating, but no water will be moving. **The pump will not work properly while air is trapped in it. Continuing to operate the pump in this way will cause damage.**

New spa owners often have difficulty the first time they start their spa and the pump fails to prime. This can be frustrating, but these simple instructions can help you.

To remove small air bubbles trapped in the pump.

1. Turn the spa on and wait for **PR** (Priming Mode) to appear on the topside display.
2. Press the JETS button to turn on the pump and let it run for 10 seconds. The pump should be running on low speed.
3. Press the JETS buttons again and let the pump run on high speed for 10 seconds.
4. Press the JETS button again to turn off the pump. The pump should be left in the off position for 10 to 15 seconds.
5. Repeat steps 1 through 4 until water is flowing through all the jets and all air is removed from the plumbing.



To remove a large air lock within the pump:

1. Turn off power at the breaker.
2. Remove the spa panel closest to the pump.
3. Loosen the white Pressure Union on top of the pump by hand or with a strap wrench. When air is bled out, tighten the union, turn breaker on and set the pump on high speed.



Note: If you press the Temp button any time during Priming Mode, it will exit that mode and begin Standard Mode.

Topside Control Panel



VS and GS SERIES One-Pump Spas

System Settings

When your spa is first actuated, it will go into Priming mode, indicated by “Pr.” The Priming mode will last for less than 5 minutes (press “Warm” or “Cool” to skip Priming Mode) and then the spa will begin to take temperature readings, followed by the heater test cycle. After completed, the heater will turn on, heat the spa and maintain the water temperature in the Standard mode.

The start-up temperature is set at 100°F/37°C. The last measured temperature is constantly displayed on the LCD. Note that the last measured spa temperature displayed is current only when the pump has been running for at least 2 minutes.

To display the set temperature, press the “Warm” or “Cool” pad once. To change the set temperature, press the pad a second time before the LCD stops flashing. Each press of the “Warm” or “Cool” pad will continue to either raise or lower the set temperature. After three seconds, the LCD will stop flashing and display the current spa temperature.

Maximum Temperature is set at 104°F/40°C as required by UL/CSA.

Minimum temperature is 80°F/26°C.

Note: If the spa is currently in a heating or filtration cycle the pump will only switch between high and low. It cannot be turned off until the heating or filtration cycle is completed.

Jets

Touch the “Jets” button once to turn the pump on or off, and to shift between low and high speeds. If left running, the low speed of the pump will automatically turn off after 2 hours, and the high speed will automatically turn off after 15 minutes.

Light

Press “Light” button to turn the light on/off. If left on, the light automatically turns off after 4 hours.

Preset Filter Cycles

The first filter cycle begins 6 minutes after the spa is energized. The second filter cycle begins 12 hours later. Filter duration is programmable for 1-8 per 12 hours. The default filter time is 2 hours.

Example 1: In a 12 hour period (1 cycle), a setting of F1 means 1 hour of filtration on, 11 hours of filtration off.

Example 2: In a 12 hour period (1 cycle), a setting of F4 means 4 hours of filtration on, 8 hours of filtration off.

You may choose F1, F2, F4, F6, or F8.

To program, press “Warm” then “Jets”. Press “Warm” to adjust. Press “Jets” to exit.

Mode

Mode is changed by pressing the “Warm” or “Cool” button, then pressing the “Light” button. In Economy and Sleep Mode, heating only occurs during the filter cycle. See Mode, page 17.

Freeze Protection

If the temperature sensors detect a drop to below 44°F/6.7°C within the heater, the pumps will automatically activate to provide freeze protection. The equipment stays on until 4 minutes after the sensors detect that the spa temperature has risen to 45°F/7.2°C or higher.

Control Pack Codes See pages 16-17.

Operate Your Spa

VS and GS SERIES Control Pack Codes	
ST	STANDARD MODE
EC	ECONOMY MODE
SL	SLEEP MODE
	Problem: No message on display. Power has been cut off to the spa. Solution: The control panel will be disabled until power returns. Spa settings will be preserved until next power up. Or .3 amp fuse is blown and needs to be replaced.
-- --	Problem: Temperature unknown. Solution: After the pump has been running for 2 minutes, the temperature will be displayed.
HH	Problem: “Overheat”- The spa has shut down. One of the sensors has detected 118°F/43 C at the heater. Solution: DO NOT ENTER WATER. Remove spa cover and allow water to cool. Once the heater has cooled, reset by pushing any button. If spa does not reset, shut off the power to the spa and call your dealer or service organization.
OH	Problem: “Overheat”- The spa has shut down. One of the sensors has detected 118°F/43 C at the heater. Solution: DO NOT ENTER WATER. Remove spa cover and allow water to cool. At 107°F/ 42 C, the spa should automatically reset. If spa does not reset, shut off the power to the spa and call your dealer or service organization.
IC	Problem: “Ice” – potential freeze condition detected. Solution: No action required. The pump will automatically activate regardless of spa status.
SA	Problem: Spa is shut down. The sensor that is plugged into Sensor “A” jack is not working. Solution: If the problem persists, contact your customer service or service organization. (May appear temporarily in an overheat situation and disappear when the heater cools.)
SB	Problem: Spa is shut down. The sensor that is plugged into Sensor “B” jack is not working. Solution: If the problem persists, contact your dealer or service organization. (May appear temporarily in an overheat situation and disappear when the heater cools.)
SN	Problem: Sensors are out of balance. If alternating with spa temperature, it may just be a temporary condition. If flashing by itself, spa is shut down. Solution: If the problem persists, your dealer or service organization.
HL	Problem: A significant difference between temperature sensors has been detected and could indicate a flow problem. Solution: Check water level in spa. Refill if necessary. If the water level is okay, make sure the pumps have been primed. If problem persists, contact your dealer or service organization.
LF	Problem: Persistent low flow problems. (Displays on the fifth occurrence of “HFL” message within 24 hours.) Heater is shut down, but other spa functions continue to run normally. Solution: Follow action required for “HFL” message. Heating capability of the spa will not reset automatically; you may press any button to reset.
	cont.

VS and GS SERIES Control Pack Codes <i>cont.</i>	
DR	<p>Problem: Possible inadequate water, poor flow, or air bubbles in detected in the heater. Spa is shut down for 15 minutes.</p> <p>Solution: Check water level in spa. Refill if necessary. If water level is okay, make sure the pumps have been primed. Press any button to reset, or this message will automatically reset within 15 minutes. If problem persists, contact your dealer or service organization. On a fresh fill your pump may be air locked. Refer to page 14 for removing an air lock.</p>
DY	<p>Problem: Inadequate water detected in heater. (Displays on third occurrence of “dr” message) Spa is shut down.</p> <p>Solution: Follow action required for “dr” message. Spa will not automatically reset. Press any button to reset. On a fresh fill your pump may be air locked. Refer to page 14 for removing an air lock.</p>

If you have an error code that will not clear, try the following:

VS and GS Pack Reset Instructions

Tools: Phillips head screwdriver
Needle nose pliers (optional)

First, turn the power off to the spa by using the breaker disconnect. Then, remove the cover to the pack (electrical control unit inside spa). Locate the board diagram on the inside of the cover, and find J43 Persistent Memory. This is located approximately 3/4” above and 1/2” to the right the red dipswitch bank. It is a small black piece of plastic located between two yellow pieces connected to the board. The jumper on J43 should be hanging on one (1) pin and in a vertical position. Using needle nose pliers (or fingers) gently grab the black jumper and remove from the board. Next, put the jumper back on the pin it came off of in the horizontal position using it to connect the adjacent pin. Proceed to turn the power back on to the spa. Once you see “PR” on the top display, wait one (1) minute and turn the breaker back off. Now reverse the process. Take the black jumper off of both pins and reposition vertically on just one pin (this is done just as a place-saver so the jumper does not become lost). Replace the cover to the pack, and power the spa back on.

Mode

Standard Mode is programmed to maintain the desired temperature. Note that the last measured spa temperature displayed is current only when the pump has been running for at least 2 minutes. “ST” will be displayed momentarily when you switch into Standard Mode. This is the best mode to use during COLD weather.

Economy Mode heats the spa to the set temperature only during filter cycles or if the temperature falls to 20 degrees below set temperature. “EC” will

display solid when temperature is not current, and will alternate with temperature when temperature is current. This is the best mode to use during WARM weather.

Sleep Mode also heats the spa to the set temperature only during filtration cycles. “SL” will display solid when temperature is not current, and will alternate with temperature when temperature is current, but only within 20 degrees of your set temperature.

Note: in all modes, the spa will turn on 1 minute each hour for a temperature reading.

Personalized Settings



Jets

Most jets in your spa are fixed. If your spa is equipped with any adjustable jets, rotating the face of an adjustable jet to the left (counter-clockwise) will decrease the amount of water flow through the jet. Rotating the face of an adjustable jet to the right (clockwise) will increase the amount of water flow through jet.



Air Controls *(if equipped)*

Air controls are the **2" knobs** located around the top of your spa. Each one will let you add a mixture of air with the jet pressure. This is accomplished by rotating the air control knob to the left (counterclockwise) to increase the amount of air-flow through the jets. To decrease the amount of air-flow through the jets, rotate the handle to the right (clockwise).



Waterfall Controls

(if equipped)

Some spas include waterfalls. Increase or decrease the flow of the waterfall using the **2" water on/off knob** near the waterfall.

Lighting

Underwater LED Light, LED Waterfall Lights *(if equipped)*



Press the **Light** button on the topside control panel to turn the spa light on. The lights operate in 4 modes:

1. Fading: The first time you press the **Light** button, the lights will cycle through all the colors in this order:

White, Cyan, Magenta, Blue, Yellow/Green, Green, Red

2. Color Locked: This cycle offers a hard color change without fading.

3. Quick Color Change: To cycle through the different color choices, press the **Light** button repeatedly. Each time you press the button, you advance to the next color.

4. Flashing white: When you have cycled through all the colors, the next time you push the **Light** button, the LED lights will flash white.

Electrical Power Efficiency

Your new spa comes equipped with an electric heater. Following the directions listed below will ensure the most efficient operation:

NOTE: This method is only for spa usage under two hours a week.

Keep the spa's operating temperature 5°F below the desired usage temperature when not in use. One or two hours before use, set the temperature to the desired temperature.

If the spa usage exceeds two hours a week, the set temperature should remain at the desired usage temperature.

Air controls (if equipped) should be used sparingly. When open, water temperature drops quite rapidly and can also dissipate chemicals.

Allowing the water temperature to lower more than 10°F below the desired usage temperature and reheating it prior to usage will cause the heater to operate longer than it normally would maintaining the desired temperature. Doing this will increase your operating cost and makes your heater work more than necessary.

Testing and Adjusting Water

As the owner of a Durasport Spa, it is important that you maintain your spa water and keep your spa equipment in excellent condition. To do so, you must first balance your spa water. If your spa is equipped with an ozone generator it will automatically produce ozone, but it cannot be used as the sole means of maintaining safe spa water. You must select and use a spa chemical system in addition to your ozone generator. The ozone generator is a wearable, non-warranty item and it needs to be replaced approximately every two years.

Routine Water Maintenance

Good spa water requires regular maintenance. Establish a routine based on a regular schedule for your spa water maintenance. Maintaining your water quality helps the enjoyment of your spa and extends your spa's life. See page 23.

Sanitation

You will need to decide which chemical sanitizer you wish to use, regardless of the presence of an ozonator. Spa owners with an ozonator still need to use a chemical sanitizer. Sanitizers kill bacteria and viruses and keep the water clean. A low sanitizer level will allow microbes to grow quickly in the spa water. Use either bromine or chlorine as your sanitizer or a non-chlorine/non-bromine sanitizer. All work well when maintained regularly. Consult your Strong Spas dealer for the right decision with regards to your lifestyle and spa usage.

This manual will cover general chlorine sanitation only. See page 20.



Durasport™ Spas does hereby claim no responsibility or liability for use of and quantities of the chemicals used.

Read and follow all label instructions.

Do not use salt-based systems in your spa! Damage caused by salt-based systems will not be covered under your warranty.

Ozone

Ozone is a natural purifier. Chemically known as O₃, it is produced from simple oxygen molecules in our atmosphere. Ozone is produced in nature from lightning during electrical storms and from ultraviolet rays from the sun. It forms our protective ozone layer. Your spa's ozone generator is designed to duplicate this natural sanitizer. Ozone breaks down and oxidizes oils, suntan lotions, sweat, urea, etc. from spa water more effectively than commercial oxidizers. Ozone works along with chemical sanitizing systems in your spa to destroy bacteria and viruses and will do so more effectively. Ozone only leaves simple oxygen in the water as a by-product.

Filtration

Cleaning your filter regularly is the easiest and most effective single thing you can do to keep your water clear. A clogged or dirty filter will cause the heater and pump to work harder than they need to, possibly causing them to fail. The spa's heating system will only function with the proper amount of water flow through the system. See page 22.

The filtering cycle of your spa should be operated at least two hours or more a day (whether or not the heater is heating) to remove impurities and to prevent disposition of contaminants in your spa. The filtering system works automatically. Keep the spa covered when not in use to reduce the loss of heat and to keep debris from settling in the water. See page 15.

Chemical Balance

You will need to test and adjust the chemical balance of your spa water. Although this is not difficult, it needs to be done regularly. Depending on your choice of sanitizer, you need to test the level of calcium hardness, total alkalinity, and pH. See pages 20-23.

Testing Methods

There are 2 types of testing methods:

- The reagent test kit is a method which provides a high level of accuracy. It is available in either liquid or tablet form.
- Test strips are a convenient testing method commonly used by spa owners.

Maintaining Spa Water Quality

Balancing the Total Alkalinity

Total alkalinity (TA) is the measure of the total levels of carbonates, bicarbonates, hydroxides, and other alkaline substances in the water. TA can be considered a pH buffer. It is the measure of the ability of the water to resist changes in pH level.

The recommended total alkalinity is 80 - 120 ppm.

If the TA is too low, the pH level will fluctuate widely from high to low. Low TA can be corrected by adding **alkalinity increaser**.

If the TA is too high, the pH level will tend to be too high and may be difficult to bring down. High TA can be corrected by adding **pH decreaser**.

When the TA is balanced, it normally remains stable, although adding water with high or low alkalinity will raise or lower the TA level.

Balancing the Calcium Hardness

Calcium hardness (CH) is a measure of the total amount of dissolved calcium in the water. Calcium helps control the corrosive nature of the spa's water and is why soft water is not recommended. The low calcium content of soft water is very corrosive to the equipment and can cause staining of the spa shell.

The recommended calcium hardness is 150 - 200 ppm.

If the CH is too low, add liquid hardness increaser.

If the CH is too high, dilute the spa water with soft water or, if this is not available, add stain and scale defense.

When the CH is balanced, it normally remains stable, although adding soft water or very hard water will raise or lower the CH level.

Balancing the pH

The pH level is the measure of the balance between acidity and alkalinity.

The recommended pH is 7.2 - 7.6.

Too alkaline, causes scaling	8.2	↓ Decrease the pH level.
	8.0	
	7.8	
Ideal balance	7.6	
	7.4	
	7.2	
Too acidic, causes corrosion.	7.0	↑ Increase the pH level.
	6.8	
	6.6	

If the pH is too low, it can cause corrosion of metal fixtures and the heating element. See chart to balance.

If the pH is too high, it can cause scaling by allowing metals or minerals to form deposits and stain spa surfaces. See chart to balance.

If Using Chlorine as a Sanitizer

- If you choose to use chlorine as a sanitizer, only use granulated chlorine, not liquid chlorine.
- Once a week, check the chlorine level using either a test strip or a reagent kit. See table for the ideal range.
- Add one or two tablespoons of chlorinating granules to the spa water weekly. Note that chlorine dissipation rate will be faster at higher water temperatures and slower at lower temperatures.
- When you add chlorine, make sure no bathers are in the spa, open all jets and run the spa at high speed with the cover open for at least 30 minutes.
- Follow the maintenance schedule on page 23.

If Using Bromine as a Sanitizer

Bromine is a very effective sanitizer that produces low chemical odors. Unlike chlorine, it can break down bacteria and other impurities to a safe level with a low burn-out rate. The bromine generator requires different water chemistry tests from chlorine systems.

If you choose to use a bromine generator, you can purchase one at your Strong Spa retailer or other local spa retailer. Retail specialists will help you determine the best product to purchase and can rec-

Test for:	Ideal Range Min. < > Max.	Chemicals to Use	
		To Raise	To Lower
Total Alkalinity	80 ppm < > 120 ppm	alkalinity increaser	pH decreaser
Calcium Hardness	150 ppm < > 200 ppm	hardness increaser (liquid or powder)	stain scale inhibitor
pH	7.2 < > 7.6	pH increaser	pH decreaser

Test for:	Ideal Range (ppm)		Chemicals to Use To Raise
	Min.	Max.	
Chlorine level without ozonator with ozonator	3.0 2.0	5.0 4.0	chlorinating granules

Chemical Safety

Read and follow all printed instructions listed on bottles and packages. Failure to follow chemical directions may result in serious injury, sickness, or even death.

Add chemicals to the center of the spa with the pump running. Make sure the water is heated. Never add chemicals to cold water, as this will effect chemical action. Also, never add chemicals directly into the skimmer.

 **WARNING!**
Never add chemicals to your spa while bathers are in the spa!

 Do not exceed chemical dosages as recommended on chemical bottles and packages.

 Never change chemical brands or types without completely draining, flushing and thoroughly cleaning the spa and cover first.

 **WARNING!**
Never mix chemicals together.

 Do not allow chemicals to come in contact with skin, eyes or clothing. Remove and wash clothing that may have been exposed to chemical contact prior to wearing them again.

 Inhaling or ingesting chemicals will cause serious injury, sickness, or even death.

 Chemicals must be stored completely out of the reach of children in an area that is well vented, cool, and dry. Failure to provide a proper area for chemical storage may result in serious injury, sickness, fire explosion and even death. Do not store your chemicals inside the equipment area of your spa.

Maintaining Spa Water Quality

ommend supplies, procedures and maintenance schedules.

Shocking the Water

In addition to using a chemical sanitizer, you will periodically need to shock the water. Shocking the water helps remove burned-out chemicals, bacteria, and other organic material from your spa's water and improves your sanitizer's effectiveness.

Do not use chlorinating shock, which will damage your spa's jets and pump seals. Only use **oxidizer shock**. It is an easy way to maintain chemical plans.

For best results use the directions below.

Add one ounce of oxidizer shock:

- Once a week
- After heavy bather loads
- If water has a strong odor

Spa must be running with all of the jets on high for 30 minutes with the cover open. If necessary, repeat oxidizer shock in 30 minute intervals.

Filter Cleaning

The filter is the part of your spa that removes the debris from the water and needs to be cleaned on a regular basis to maximize your spa's filtering performance and heating efficiency.

In addition to spraying off the filter weekly to remove surface debris, your filter should be deep cleaned periodically to dissolve scale and particles that get lodged deep within the filter fibers and impede the filtration process. Even if the filter looks clean, scale and particles can clog the fibers and prevent water from flowing through the filter resulting in the most common spa problem – no heat, caused by a dirty filter.

We recommend you clean your filter once a month and replace it once every 6 months or as necessary.

1. Remove the filter by turning it counterclockwise, unscrewing the bottom threads, then pulling it up and out.
2. Place the dirty filter into a bucket of water deep enough to cover the filter. Add 8 oz of liquid filter cleaner to the bucket of water.
3. Soak the filter for a minimum of 24 hours.

4. Spray pleats of the filter with a water hose.

5. Reinstall the filter.

Tip: Keep a spare filter to use in the spa while the dirty filter is being deep cleaned.

Starting with Fresh Water

Consult dosage recommendations on the containers that your chemicals are packaged in since they may have similar names and/or usage descriptions but due to manufacturing differences, there is the likelihood of under- or over-dosing the spa chemicals. Damage to the spa or spa components from improper chemical usage is not covered under the spa's warranty. **Important: Make sure the water is heated. Never add chemicals to cold water, as this will effect chemical action. Add chemicals to the center of the spa with the pump running.**

Prior to filling a spa for the first time, or after a routine draining, follow this start-up procedure. Adjust the chemical dosages to the capacity of your particular spa, following label recommendations.

1. Clean the surface of the spa with non-abrasive cleaner.
2. Fill the spa to the proper water level with normal tap water. (Do not use soft water.) Heat your spa to at least 90°.
3. Use test strip and balance the spa water.
 - Adjust total alkalinity (acceptable range is 80-120ppm).
 - Adjust pH if necessary (between 7.2 to 7.8).
4. Add stain and scale prevention.
5. Add two tablespoons of chorine granules to the spa water.
6. Turn on jets for 15 minutes. Leave spa uncovered during this time.
7. Put cover on spa and allow to heat up to desired temperature.

Water level is very important. If the water level is too low or too high, your spa will not operate properly. The water level should be about two inches over the highest jet when the spa is not being used.

Maintenance Schedule

Each time you refill the spa

- Follow the directions in the section *Starting with Fresh Water*.

Prior to each use

- Test the spa water using either test strips a reagent test kit. Adjust chemical levels as necessary.

Once a week

- Test the spa water using either test strips a reagent test kit. Adjust chemical levels as necessary.

Once a month

- Deep clean your spa's filter. See page 22.
- Apply spa vinyl cleaner/protectant to vinyl spa soft cover.

Every two to three months

- Drain and clean your spa with non-abrasive cleaner.
- Refill your spa, following the directions in the section *Starting with Fresh Water*.

Every four to six months

- Change your spa water. You may find the need to change your spa water more frequently with heavy use. When empty, your spa should be cleaned with a non-abrasive cleaner and then rinsed thoroughly.

Once a year

- Replace filter cartridges if the pleats appear frayed.

Every 2 years

- Replace your ozonator (if equipped).



Troubleshooting Water Quality Problems

Problem	Probable Causes	Possible Solutions
Water is cloudy	<ul style="list-style-type: none"> • Dirty filter • Inadequate or improper sanitizing • Oils, lotions, organic matter • Old water 	<ul style="list-style-type: none"> • Clean the filter • Run jet pumps and clean filter • Add sanitizer • Shock spa with sanitizer • Adjust pH or alkalinity to balance • Drain and refill spa
Algae	<ul style="list-style-type: none"> • pH too high • Sanitizer too low 	<ul style="list-style-type: none"> • Shock spa with Sanitizer. Adjust pH • Shock spa with sanitizer and maintain good sanitizer level
Organic buildup or scum ring around spa	<ul style="list-style-type: none"> • Oils, dirt in spa water 	<ul style="list-style-type: none"> • Wipe off scum ring using a clean rag. In extreme cases, you may need to drain, clean and refill your spa.
Water odor	<ul style="list-style-type: none"> • Organics • Inadequate or improper sanitizing • pH too low 	<ul style="list-style-type: none"> • Shock spa with sanitizer • Add sanitizer • Adjust pH to balance
Chlorine odor	<ul style="list-style-type: none"> • Chloramine level too high • pH too low 	<ul style="list-style-type: none"> • Shock spa with sanitizer • Adjust pH to balance
Musty odor	<ul style="list-style-type: none"> • Algae or bacteria 	<ul style="list-style-type: none"> • Shock spa with sanitizer. If problematic or visible, you may need to drain, clean and refill your spa.
Eye irritation	<ul style="list-style-type: none"> • pH too low • Sanitizer too low 	<ul style="list-style-type: none"> • Adjust pH to balance • Shock spa with sanitizer and maintain good sanitizer level
Skin irritation or rash	<ul style="list-style-type: none"> • Unsanitary water quality • Free chlorine level too high (above 5 ppm) 	<ul style="list-style-type: none"> • Shock spa with sanitizer and maintain good sanitizer level • Allow level to drop naturally to below 5 ppm before using spa
Stains	<ul style="list-style-type: none"> • Total alkalinity and/or pH are too low • High amounts of copper or iron in water 	<ul style="list-style-type: none"> • Adjust total alkalinity and/or pH • Use stain and scale inhibitor
Scale	<ul style="list-style-type: none"> • Calcium content of water is too high. Total alkalinity and pH are too high. 	<ul style="list-style-type: none"> • Adjust total alkalinity and pH. If needed, drain spa, scrub off scale, then refill and balance water. • Use stain and scale inhibitor

Troubleshooting Operations

Symptom	Possible Cause(s)	Possible Solution(s)
POWER		
System does not work	Power is turned off	Reset spa
Control pad and spa equipment do not operate	No electrical power to spa	Turn on or reset the GFCI circuit breaker. If this does not solve the problem, have a qualified electrician check the electrical service.
	The 30A fuse has blown	Contact your dealer
The spa does not turn off	Spa is trying to heat up	Check the temperature setting is in Standard mode
	Spa is in filter cycle	Normal. No adjustment necessary
	Spa is in Standard mode	Check setting
Control panel displays a message	An error may have occurred	See Diagnostic Messages on pages 16-17 for message code meanings
GFCI breaker trips repeatedly	Improper wiring to spa or GFCI breaker is defective	Consult with a qualified electrician
	There is a defective component on spa	Contact your dealer
HEAT		
Spa does not heat	Check mode. Set to Standard or Ready	See control panel instructions on pages 15-17.
	Water level is too low	Add water to correct level
	No electrical power to spa	Turn on or reset the GFCI circuit breaker. If this does not solve the problem, have a qualified electrician check the electrical service.
	Heater is defective	Contact your dealer
	Gate valve is partially or fully closed	Open gate valves. Note: Never operate your spa with the gate valves closed!
Spa gets warm but not hot	Thermostat has been turned down	Set control panel to higher temperature
	Insufficient filtration time if Sleep or Economy mode	Increase filtration time
	Water level is too low	Add water to correct level
	No electrical power to spa	Turn on or reset the GFCI circuit breaker. If this does not solve problem, have a qualified electrician check the electrical service.
	Dirty filter cartridge	Clean filter cartridge
	Gate valves closed	Open gate valves
	Spa cover improperly positioned	Align spa cover
Spa gets too hot	Filtration time is set too long	Reduce filtration cycles, especially during summer months

Troubleshooting Operations

Symptom	Possible Cause(s)	Possible Solution(s)
WATER		
<i>Water is not clean</i>	For all water clarity problems, see page 25	
<i>High water consumption</i>	Very high evaporation due to air valves being open	Shut off air valves and refill as necessary
<i>Low water stream from the jets</i>	Running in FILTER mode - slow speed	Select high speed jets
	Blocked wall suction or skimmer	Clean wall suction/skimmer.
	Dirty filter	Clean filter and replace
	Jets are closed	Open jets
	Valves closed	Open valves
<i>No water stream from the jets</i>	Pump has airlock	Remove airlock by priming spa (page 14)
	Jets are closed	Open jets
	Power switched off, system off	Reset power
	Pump is defective	Contact your dealer
	Pump fluctuations	Low water. Check level on skimmer flap
<i>Water leakage from below spa</i>	Loose connections and drain hoses	Tighten loose connections
WATER PRESSURE		
<i>Jets surge on and off</i>	Water level is too low	Add water to normal level
<i>Jets are weaker than normal or do not work at all</i>	Jet valves are partially or fully closed	Open jet valves
	Filter cartridge is dirty	See Cleaning the Filter
	Air is trapped in the pump	Remove airlock by priming spa (page 14)
	The suction fittings are blocked	Remove any debris that may be blocking the suction fittings
	Gate valve is closed	Open gate valves. Note: Never operate spa with the gate valves closed!
AIR AND JETS		
<i>No airstream from the jets</i>	Air control not open	Open the control
	Jet spout opening not fixed properly	Check jet spout openings
	Jet spout opening missing	Check jets and replace as necessary
LIGHT(S)		
<i>Standard spa light doesn't work</i>	Light bulb has burned out	Replace light bulb
	Lighting system is defective	Contact your dealer

Troubleshooting Operations

Symptom	Possible Cause(s)	Possible Solution(s)
PUMP(S)		
<i>Pump runs constantly – will not shut off</i>	Problem with circuit board	Contact your dealer
<i>Noisy pump</i>	Water level is too low	Add water to normal level
	Blocked wall suction or skimmer	Clean the wall suction/skimmer
	Damaged or worn-out motor block	Contact your dealer
	Clogged floor suction or skimmer	Clean floor suction or skimmer
	Leakage of air into suction line	Contact your dealer
	Debris is inside pump	Contact your dealer
	Gate valves are closed	Open gate valves. Note: Never operate your spa with the gate valves closed!
	Damaged or worn motor bearings	Contact your dealer
	Improper or defective wiring	Contact your dealer
<i>Pump turns off during operation</i>	Automatic timer has completed its cycle	Start the cycle again
	The pump motor is defective	Contact your dealer
<i>Pump has a burning smell while running</i>	Damaged or worn motor bearings	Contact your dealer
<i>Pump does not work</i>	Power may be turned off	Reset power
	Pump has overheated	Let cool for one hour
	Incorrect or faulty wiring of electrical supply	Contact your dealer
	Switch is off	Auto reset after the motor has cooled down
	House circuit breaker tripped or in OFF position	Reset circuit breaker Contact your dealer
	Motor overload condition	Motor overload will reset automatically. If problem persists, contact your dealer
	Damaged electrical cord	Contact your dealer
	Pump cord not plugged in	Plug pump cord into red receptacle
	GFCI tripped or in OFF position	Reset GFCI

Draining Your Spa

Your spa should be drained every 4 to 6 months and refilled with fresh tap water. The following is the recommended method for draining your spa.

1. Turn off the power at the breaker.
2. Remove all filters.
3. Your drain valve is located inside the spa cabinet.
4. Locate hose ending with the 3/4 inch hose shut-off valve.
5. Hook up the female end of a garden hose to the drain fitting.
6. Place the other end of the garden hose where you would like the water to drain to.
7. Twist the hose shut-off valve counterclockwise to open the drain.
8. Let spa drain, then remove garden hose.
9. Twist the hose shut-off valve clockwise to close it and replace cap.



Water drained from your spa is safe to dispose of in your yard, septic system or in a drain. Follow all local/municipal codes and regulations for disposal.

Vacation Care

You can leave your spa unattended for up to two weeks if you follow these instructions.

- ALWAYS lock your cover using the cover locks if you plan to be away from home and the spa is filled with water.
- Set the spa to Sleep Mode. (See instructions on page 15, 16 for changing modes.)
- Following the water quality instructions starting on page 19, adjust the pH.
- Shock the water (add either chlorine or bromine sanitizer).
- When you return, check and adjust the pH and shock the water.

If you will not be using your spa for longer than 14

days and a spa maintenance service is not available, we strongly recommend you drain or winterize your spa. See page 30 for Winterization Procedure.

Jet Removal and Replacement

1. Insert a Fixed Jet Removal Tool (Figure 1) into the jet face (Figure 2).
2. Turn the jet counterclockwise (Figure 3) until it rotates out of the spa (Figure 4).

To replace jets, insert jet in the jet well and rotate clockwise until you feel it tighten into position.



Resin Spa Surface

- For normal cleaning, use a soft cloth with soap and water. Rinse well and dry with a soft, clean cloth.
- Clean grease, oil, paint and ink stains with isopropyl (rubbing) alcohol. Rinse well and dry with a soft, clean cloth.
- Never use abrasive cleaners.
- Do not allow spa surface to come into contact with nail polish, nail polish remover, wintergreen oil (methyl salicylate), dry cleaning solution, lacquer thinners, gasoline, pine oil, etc.
- Avoid placing sharp instruments on spa surface as they may scratch it. Small scratches can be removed by buffing lightly with a clean cloth and using either an automotive polishing liquid or a toothpaste containing a fine polishing ingredient. For deeper scratches, sand the surface lightly with 400 grit “wet or dry” paper and buff with fine-grit buffing compound.

Winterization Procedure

Important: Damage caused by improper winterization is not covered under the Durasport Spas Warranty.

1. Turn off power at the GFCI circuit breaker before draining or servicing your spa.
2. Gain access to spa components by one of the following methods:
 - a. Open access door (roto spas except G-2)
 - b. Pry off panel screw covers and remove screws to remove panels (G-2 spas) (Figure 1)
3. Attach a garden hose to the drain and open the blue ball valve (Figure 2). Water will start to drain. You may have some water left in the spa shell that did not drain. Remove it with a wet-vac or by hand with a small cup.

Water drained from your spa is safe to dispose of in your yard, septic system or in a drain. Follow all local/municipal codes and regulations for disposal.

4. Loosen all large white unions from heater and pump to let excess water drain from the lines (Figure 3).
5. Remove lowest drain plug on front of pump (Figure 4). Drain out any water in pump.
6. After the spa has drained, you MUST also use a wet-vac to remove the water from the lines by vacuum/suction. Water left in the lines and jets will freeze and damage them.

To adequately clean out the lines, place the wet-vac for 10-15 seconds over: each drain (Figure 5); each union (Figures 6 and 7); each jet face (Figure 8); each suction (Figure 9); and the filter cavity (Figure 10). See *filter removal procedure*.

7. After all the water is removed from the spa, jets, and plumbing, re-insert drain plug into pump (Figure 4). Tighten all unions and make sure all gate valves are open with clips installed (Figure 3).
8. Pour a gallon of spa antifreeze into the top of pump (Figure 11) and a gallon into the filter cavity (Figure 12).
9. Replace all exterior panels.
10. Close your spa cover.

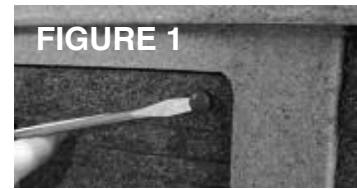

FIGURE 1



FIGURE 2



GATE VALVE/CLIP

UNION

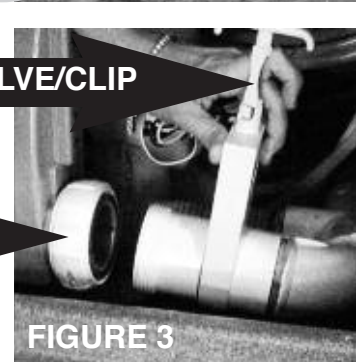

FIGURE 3



FIGURE 4

PLUG



FIGURE 5

Winterizing and De-Winterizing Your Spa



FIGURE 6



FIGURE 10

Important: Damage caused by improper winterization is not covered under the Durasport Spas Warranty.

If you have any questions, please call Durasport Spas Technical Support at 1-800-787-6649.

You may also wish to contact a professional to perform these services for you.



FIGURE 7



FIGURE 11

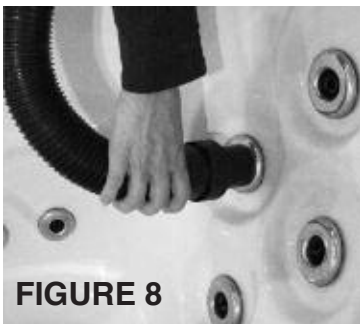

FIGURE 8



FIGURE 12



FIGURE 9

De-Winterization Procedure

1. Fill the spa's footwell with water.
2. Drain the spa to clear the antifreeze out of the spa. See page 29. *Draining Your Spa*, for procedure.









Water drained from your spa is safe to dispose of in your yard, septic system or in a drain. Follow all local/municipal codes and regulations for disposal.



Spa Parts Catalog

Part Name	Part #	Manuf. Part #	Manufacturer	Description
<p>MOLDED SPA PARTS (FILTER COVERS . SHELLS . DOORS . PANELS . STEPS . ICE BUCKETS . TRAYS)</p>				
	ACR/FILTCOVMILMLD ACR/FILTCOVGRYMLD ACR/FILTCOVSNMMLD ACR/FILTCOVSNMMLD	(SAME AS PART #)	STRONG INDUSTRIES	FILTER COVER MILL FILTER COVER GREY FILTER COVER SAND FILTER COVER MAH
	SPA/CMP25396-004	25396-004-000	CUSTOM MOLDED PRODUCTS	CMP/ 2-CUP FILTER LID / BLK
	G2SPA/CNRMILMLD G2SPA/CNRGRYMLD G2SPA/CNRSNDMLD	(SAME AS PART #)	STRONG INDUSTRIES	G-2 CORNER MILL G-2 CORNER GREY G-2 CORNER SAND
	ATGSPA/DRMILMLD ATGSPA/DRGRYMLD ATGSPA/DRSNDMLD	(SAME AS PART #)	STRONG INDUSTRIES	ANTIGUA DOOR MILL ANTIGUA DOOR GREY ANTIGUA DOOR SAND
	RIOCYP/DRMILMLD RIOCYP/DRGRYMLD RIOCYP/DRSNDMLD	(SAME AS PART #)	STRONG INDUSTRIES	RIO CYPRUS DOOR MILL RIO CYPRUS DOOR GREY RIO CYPRUS DOOR SAND
	ACR/FDPRKMILMLD ACR/FDPRKGRYMLD ACR/FDPRKSNMMLD	(SAME AS PART #)	STRONG INDUSTRIES	G-2 PANEL MILL G-2 PANEL GREY G-2 PANEL SAND

Parts Catalog

	SPA/SSMILMLD SPA/SSGRYMLD SPA/SSNDMLD SPA/SSMAHMLD	(SAME AS PART #)	STRONG INDUSTRIES	STORAGE STEP MILL STORAGE STEP GREY STORAGE STEP SAND STORAGE STEP MAH
	SPA/TDMILMLD SPA/TDGRYMLD SPA/TDSNDMLD SPA/TDMAHMLD	(SAME AS PART #)	STRONG INDUSTRIES	STEP TREAD MILL STEP TREAD GREY STEP TREAD SAND STEP TREAD MAH
	ACR/SDRMILMLD ACR/SDRGRYMLD ACR/SDRSNDMLD	(SAME AS PART #)	STRONG INDUSTRIES	FOLD STEP DOOR- MILL FOLD STEP DOOR- GREY FOLD STEP DOOR- SAND
	G2SPA/TDRMILMLD G2SPA/TDRGRYMLD G2SPA/TDRSNDMLD	(SAME AS PART #)	STRONG INDUSTRIES	TOWEL DOOR- MILL TOWEL DOOR- GREY TOWEL DOOR- SAND
	ATGSPA/IBMILMLD ATGSPA/IBGRYMLD ATGSPA/IBSNDMLD	(SAME AS PART #)	STRONG INDUSTRIES	ANTIGUA ICE BUCKET MILL ANTIGUA ICE BUCKET GREY ANTIGUA ICE BUCKET SAND
	RIOCYP/IBMILMLD RIOCYP/IBGRYMLD RIOCYP/IBSNDMLD	(SAME AS PART #)	STRONG INDUSTRIES	RIO CYPRUS ICE BUCKET MILL RIO CYPRUS ICE BUCKET GREY RIO CYPRUS ICE BUCKET SAND
	ATGSPA/TRMILMLD ATGSPA/TRGRYMLD ATGSPA/TRSNDMLD	(SAME AS PART #)	STRONG INDUSTRIES	ANTIGUA TRAY MILL ANTIGUA TRAY GREY ANTIGUA TRAY SAND
	CYPSPA/TRMILMLD CYPSPA/TRGRYMLD CYPSPA/TRSNDMLD	(SAME AS PART #)	STRONG INDUSTRIES	CYPRUS TRAY MILL CYPRUS TRAY GREY CYPRUS TRAY SAND

Parts Catalog

	RIOSPA/TRMILMLD RIOSPA/TRGRYMLD RIOSPA/TRSNDMLD	(SAME AS PART #)	STRONG INDUSTRIES	RIO TRAY MILL RIO TRAY GREY RIO TRAY SAND
-----------------------------------------------------------------------------------	-------------------------------------------------------	------------------	-------------------	-------------------------------------------------

CONTROLS
(TOPSIDE CONTROLS . WATERFALL CONTROLS . AIR CONTROLS)

	SPA/BIMVP240TSD	54678-01	BALBOA	BALBOA MVP240 TOPSIDE DISPLAY / PN5
	SPA/WW600-3051	600-3051	WATERWAY	2" TOP ACCESS DIVERTER VALVE BLK
	SPA/WW600-4711	600-4711	WATERWAY	WATERFALL / ¾" 180 DEG ON/OFF VALV
	SPA/WW660-3561	660-3561	WATERWAY	F.A.S 1" TOP ACCESS AIR CONTROL BLK SCALLOP STYLE
	SPA/WW660-4401	660-4401	WATERWAY	1" TRUE SEAL AIR CONTROL ASSY.
	SPA/WW711-2070	711-2070	WATERWAY	1" AIR CONTROL GROMMET GASKET OPAQUE

JETS
(JET BODY ASSEMBLYS . ADJUSTABLE . FIXED . DIRECTIONAL . MASSAGE . PULSATORS . ADJUSTMENT RINGS .
SUCTIONS)

	SPA/WW212-1501SSM	212-1501SSM	WATERWAY	ADJ. CLUSTER STORM INTERNAL DIRECTIONAL MTL ESC ¼" NZL 2" JET
-------------------------------------------------------------------------------------	-------------------	-------------	----------	------------------------------------------------------------------------

Parts Catalog

	SPA/WW229-1501SSM	229-1501SSM	WATERWAY	ADJ. CLUSTER STORM INTERNAL DIRECTIONAL MTL ESC ¾" NZL 2" THREAD - IN DIRECTIONAL STAINLESS JET
	SPA/WW212-1521S	212-1521S	WATERWAY	ADJ. CLUSTER STORM INT PULSATOR MTL ESC. 2" JET
	SPA/WW229-1521S	229-1521S	WATERWAY	ADJ. CLUSTER STORM INT PULSATOR MTL ESC. 2" THREAD - IN STAINLESS JET
	SPA/WW212-9821S	212-9821S	WATERWAY	NON-ADJ. OZONE W/F WITH METAL 7/16" HEX 2" JET
	SPA/WW212-9901S	212-9901S	WATERWAY	NON-ADJ. OZONE W/F WITH METAL 7/16" HEX 2" LARGE FACED FIXED STAINLESS JET
	SPA/WW215-9821	215-9821	WATERWAY	NON-ADJ. W/F 7/16" HEX TEXT. THICK/MTL - VIRGIN PVC 2" JET
	SPA/WW215-9901	215-9901	WATERWAY	NON-ADJ. W/F 7/16" HEX TEXT. THICK/MTL - VIRGIN PVC 2" LARGE FACED FIXED JET
	SPA/WW212-1541	212-1541	WATERWAY	ADJ. CLUSTER STORM INT. DIRECT. TEXT 5SCLP ESC. 2" JET
	SPA/WW229-1541	229-1541	WATERWAY	ADJ. CLUSTER STORM INT. DIRECT. TEXT 5SCLP ESC. 2" THREAD - IN DIRECTIONAL BLK JET
	SPA/WW212-1560G	212-1560G	WATERWAY	¾" SB X 3/8" EB ADJ CLUSTER STORM JET 2" JET

Parts Catalog

	SPA/WW228-1560G	228-1560G	WATERWAY	¾" SB X 3/8" EB ADJ CLUSTER STORM JET 2" JET THREADED
	SPA/WW212-1591	212-1591	WATERWAY	ADJ. CLUSTER STORM INT. PULSATOR TEXT 5SCLP ESC. 2" jet
	SPA/WW229-1591	229-1591	WATERWAY	ADJ. CLUSTER STORM INT. PULSATOR TEXT 5SCLP ESC. 2" THREAD - IN BLK JET
	SPA/WW212-7801S	212-7801S	WATERWAY	MINI STORM MESSAGE INT. METAL ESC BLK 3" JET
	SPA/WW229-9981SSM	229-9981SSM	WATERWAY	MINI STORM MESSAGE INT. METAL ESC BLK 3" FACE THREAD - IN STAINLESS JET
	SPA/WW212-7921SL	212-7921SL	WATERWAY	LED MINI STORM DIRECTIONAL INT. MTL. ESC, ¼ 3" JET
	SPA/WW229-9971SSM	229-9971SSM	WATERWAY	LED MINI STORM DIRECTIONAL INT. MTL. ESC, ¼ 3" FACED THREAD - IN STAINLESS JET
	SPA/WW212-0330G	212-0330G	WATERWAY	MINI STORM JET BODY ASSY. ¾"SB X 3/8"RB GRM 3" JET 3" JET
	SPA/WW212-0330GL	212-0330GL	WATERWAY	MINI STORM JET BODY ASSY. ¾" SB X 3/8" RB LED GROMMET 3" JET
	SPA/WW212-0430G	212-0430G	WATERWAY	POLY STORM BDY ASSY. ¾" " SB X 3/8" RB GROM. 4" JET
	SPA/WW212-8411SSM	212-8411SSM	WATERWAY	MINI STORM DIRECT. INT XLRG METAL ESC ¼" NOZ 4" JET

Parts Catalog

	SPA/WW212-8431SSM	212-8431SSM	WATERWAY	MINI STORM TWIN ROTO INT. XLRG MTL. ECS - 3/4" NOZ 4" JET
	SPA/WW212-0550G	212-0550G	WATERWAY	OZONE CLUSTER JET ELL BDY 3/8" X 3/4" 5" JET
	SPA/WW660-2550	660-2550	WATERWAY	TOP-FLO AIR INJECTOR 3/8" BARB BODY
	SPA/WW670-2550	670-2550	WATERWAY	OZONE AIR INJECTOR 3/8" BARB BODY S/S ESC.
	SPA/CMP23410-300	23410-300-000	CUSTOM MOLDED PRODUCTS	CLUSTER JET ELL BODY / 3/4" R
	SPA/WW218-5150	218-5150	WATERWAY	SELF -ALIGNMENT RING, CLUSTER STORM JET
	SPA/WW711-0010	711-0010	WATERWAY	GASKET FOR MINI JET/AIR CONTROL
	SPA/WW718-2400	718-2400	WATERWAY	SELF ALIGNING SPACER, 200 GPM SUCTION
	SPA/WW718-6960	718-6960	WATERWAY	WASHER, MINI STORM JET
	SPA/WW640-3941VP	640-3941VP	WATERWAY	264 GPM ULTRA HI-FLO 2" ASSY SUCTION

Parts Catalog

ACCESSORIES (LIGHTING . FILTERS)				
	SPA/SL400372-N	400372-N	SLOAN LED	SLOAN LED / BULLET LENS WITH NUT
	SPA/SL410117-60	410177-60-0	SLOAN LED	SLOAN LED / 5' JUMPER CABLE
	SPA/SL701564-4-D	701564-4-DLSO	SLOAN LED	701564-4-DLO QUAD (4) DAISY CHAIN XL
	SPA/701570-14	701570-14-DLSO	SLOAN LED	701570-14-DLSO
	SPA/SL701739-SA	701739-SA	SLOAN LED	SLOAN LED / ULTRABRITE 12 LED LIGHT
	SPA/SL70186-9-P	70186-9-P	SLOAN LED	ULTRABRITE MINI 9 LED LIGHT WITH BI
	SPA/WW630-K208	630-K208	WATERWAY	5" JUMBO LIGHT SKT & PIGTAIL W/2 PIN AMP CONN.
	SPA/WW630-5215	630-5215	WATERWAY	SPA LIGHT OEM KIT W/2 PIN CONN. NO LENSES, NO BULB

Parts Catalog

	SPA/WW633-1000	633-1000	WATERWAY	LIGHT LEAD W/2 PIN CONN.
	SPA/WW675-4008L	675-4008L	WATERWAY	6" LED WATERFALL ASSY. CLEAR
	SPA/PLRB50-in-4	SPA/PLRB50	PLEATCO	ACRYLIC FILTER 50FT SQ
	SPA/6.87FILCART	PSANT20P3	PLEATCO	PLEATCO SPA FILTER CARTRIDGE (PSANT2
	SPA/WW510-6551	510-6551	WATERWAY	DYNA-FLO TOP MOUNT SKIM FILTER 50 SQ
	SPA/WW519-2710	519-2710	WATERWAY	WASHER/ SELF ALIGNMENT RING FOR BAYONET T/L FILTER
	SPA/WW711-3280	711-3280	WATERWAY	DOUBLE SEAL GASKET-DYNA FLO BAYONET FILTER
	SPA/CMP25232-000	2532-000-000	CUSTOM MOLDED PRODUCTS	FILTER INSERT FITTING
<p>PUMPS (BALBOA SPA PACK . 4HP PUMP . UNION . MOTOR MOUNT)</p>				
	SPA/BIVS300PAK	VS300FLX	BALBOA	BALBOA VS300 SPA PACK / PN 54626/ 4

Parts Catalog

	SPA/WW3721621-1D5A	3721621-1D5A	WATERWAY	EXECUTIVE PUMP, 56 FRAME, 4HP, 2 SPE
	SPA/WW400-6010	400-6010	WATERWAY	2 1/2" UNION PUMP END ASSY.
	SPA/MOTORMOUNT	(SAME AS PART #)	ADVANTAGE PLASTICS	MOTOR MOUNT
<p>PVC PIPING (PIPING . MANIFOLDS . BARBS . BARB ADAPTERS . TEES . UNIONS . CAPS . PLUGS . ELBOWS . COUPLING . ADAPTERS . BUSHING . SPLICES . SWEEPS . HOSE . TUBES)</p>				
	SPA/2.0PVC	2.0 PVC	FRY'S PLASTICS	2" HARD PVC PIPE (FT)
	SPA/1.5PVC	1.5 PVC	FRY'S PLASTICS	1.5" HARD PVC PIPING
	SPA/1.0-.375MAN4	(SAME AS PART #)	ADVANTAGE PLASTICS	MANIFOLD 4 BARB 1"S X 1"SPG X 3/8 SB
	SPA/2.0-.75MAN4B	(SAME AS PART #)	ADVANTAGE PLASTICS	MANIFOLD 4 BARB 2"S X 2"SPG X 3/4SB
	SPA/1.0-.375MAN4	(SAME AS PART #)	ADVANTAGE PLASTICS	MANIFOLD 4 BARB 1"S X 1"SPG X 3/8SB

Parts Catalog

	SPA/1.0BARB	(SAME AS PART #)	ADVANTAGE PLASTICS	BARB 1" X 3/4" SB
	SPA/1.5BARB	(SAME AS PART #)	ADVANTAGE PLASTICS	BARB 1.5" X 1/5" SB
	SPA/2.0BARB	(SAME AS PART #)	ADVANTAGE PLASTICS	BARB 2" X 2" SB
	SPA/WW411-3700	411-3700	WATERWAY	3/4" BARB X 3/4" BARB 90 DEGREE ELL
	SPA/CMP21032-000	21032-000-000	CUSTOM MOLDED PRODUCTS	3/4" BARB ADAPTER (3/4" SPG X 3/4" R
	SPA/WW672-4350	672-4350	WATERWAY	BARB ADAPTER 1/4" X 3/8"
	SPA/WW413-1800	413-1800	WATERWAY	TEE, 3/4" B X 3/4" B X 3/4" BARB
	SPA/WW413-1920	413-1920	WATERWAY	1"SP X (2) 3/4" SB TEE BARB ADAPTER
	SPA/WW413-1900	413-1900	WATERWAY	3/8" X 3/8" X 3/8" TEE
	SPA/WW413-4180	413-4180	WATERWAY	F.A.S BLOWER ASSIST TEE 1" TOP ACCESS A/C
	SPA/TEE1.0	401-010BC	FRY'S PLASTICS	1" PVC SOCKET TEE

Parts Catalog

	SPA/TEE2.0	401-020	FRY'S PLASTICS	2" PVC SOCKET TEE
	SPA/TEE2X1	401-249	FRY'S PLASTICS	401-249 2" X 2" X 1" TEE
	SPA/TEE2X1.5	401-251	FRY'S PLASTICS	401-251 2 X 1.5 SCH 40 PVC TEE
	SPA/TEE2.5X2	401-292	FRY'S PLASTICS	2 1/2" X 2" PVC SOCKET TEE
	SPA/1112500	111250	AIR SUPPLY OF THE FUTURE	CLEAR UNION CHECK VALVE 1.50 ID SLIP
	SPA/WW400-5670	400-5670	WATERWAY	2" UNION W/GASKET
	SPA/WW400-5990	400-5990	WATERWAY	2 1/2" UNION NUT W/2" S TAILPIECE
	SPA/BLEEDERCAP	(SAME AS PART #)	ADVANTAGE PLASTICS	2" BLEED CAP
	SPA/CAP1.0	447-010BC	FRY'S PLASTICS	447-010BC 1" CAP
	SPA/CAP2.0	447-020	FRY'S PLASTICS	447-020 2" CAP











Parts Catalog

	SPA/AIRINTAKE	AIR INTAKE	ADVANTAGE PLASTICS	1" AIR INTAKE CAP
	SPA/PLUG.75	449-007	FRY'S PLASTICS	449-007 3/4" PLUG
	SPA/PLUG1	449-010	FRY'S PLASTICS	449-010 1" PLUG
	SPA/PLUG2	449-020	FRY'S PLASTICS	449-020 2" PLUG
	SPA/STELL1.0-90	409-010	FRY'S PLASTICS	409-010 1" 90 STREET ELBOW
	SPA/STELL1.5-90	409-015	FRY'S PLASTICS	409-015 1 1/2" STREET ELBOW
	SPA/STELL2.0-90	409-020	FRY'S PLASTICS	409-020 2" 90 STREET ELBOW
	SPA/STELL1.0-45	417-010	FRY'S PLASTICS	417-010 1" 45 STREET ELBOW
	SPA/STELL2.0-45	417-020	FRY'S PLASTICS	417-020 2" 45 STREET ELBOW
	SPA/STELL1.5-45	423-015	FRY'S PLASTICS	423-015 1 1/2" 45 STREET ELBOW SP X SL

Parts Catalog

	SPA/STELL2.0-45	423-020	FRY'S PLASTICS	423-020 2" 1/2" STREET ELBOW SP X S
	SPA/STELL1.0-45	427-010	FRY'S PLASTICS	427-010 1" 1/2" STREET ELBOW
	SPA/STELL1.5-45	427-015	FRY'S PLASTICS	427-015 1 1/2" 1/2" STREET ELBOW
	SPA/COUPLE3/4	429-007	FRY'S PLASTICS	429-007 3/4" COUPLING
	SPA/COUPLE1	429-010BC	FRY'S PLASTICS	429-010 1" COUPLING
	SPA/COUPLE2	429-020	FRY'S PLASTICS	429-020 2" COUPLING
	SPA/FADAPTER1	435-010	FRY'S PLASTICS	435-010 1" FEMALE ADAPTER
	SPA/MADAPTER1	436-010BC	FRY'S PLASTICS	436-010 1" MALE ADAPTER
	SPA/MADAPTER.75	MHT-103	FRY'S PLASTICS	MHT-103 3/4" MALE ADAPTER 9MIPT X S
	SPA/RED2X1.5	437-251	FRY'S PLASTICS	437-251 2" X 1 1/2" BUSHING
	SPA/RED2.5X2	437-292	FRY'S PLASTICS	437-292 2 1/2" BUSHING

Parts Catalog

	SPA/STELL2.0-45	423-020	FRY'S PLASTICS	423-020 2" 45 STREET ELBOW SP X S
	SPA/CMP21005-000	21005-000-000	CUSTOM MOLDED PRODUCTS	2" SWEEP 90 DEGREE ELL, SLIP X SLIP
	SPA/CMP21006-000	21006-000-000	CUSTOM MOLDED PRODUCTS	2" STREET SWEEP 90 DEGREE ELL, SLIP
	SPA/WW411-9100	411-9100	WATERWAY	WATERWAY / 1-1/2" 90 DEGREE STREET SWEEP
	SPA/.38TUBE-1FT	CT0510400-40S	TEK TUBE	3/8" CLEAR-TEK HOSE - 1 FOOT -400
	SPA/2.0HOSE-1FT	SGNG200050-15S	TEK TUBE	2" NEU-GEN SPA HOSE
	SPA/.75TUBE-1FT	CT1216150-40S	TEK TUBE	3/4" VINYL TUBE - 1 FOOT 150 FT PE
<p>OTHERS (OZONATOR . SCREWS . NUTS . BOLTS . WASHERS . CLAMPS . WIRES . CORDS)</p>				
	SPA/XL70	XL70	AQUA SUN OZONE	SPA OZONATOR W/UNIV PWR SUPPLY
	SPA/2SLICEVALVE	0412-20	MAGIC PLASTICS	2" UNIBODY VALVE SLIP X SPIG #0412-
	FAST.25X1.5HEXLA	22059	FASTENAL	FASTENAL 1/4 X 1 1/2 HEX LAG SCREW

Parts Catalog

	FAST.25X2HXL	22063	FASTENAL	FASTENAL 1/4 X 2 HEX LAG SCREW
	FAST6X1 5/8GALVD	1132169	FASTENAL	FASTENAL 6 X 1 5/8 GALV DRYWALL SCREW
	FAST6X1BDRYWALLS	1132169	FASTENAL	FASTENAL 6X1 BLK DRYWALL SCREW
	FAST.25X20FLANGE	37337	FASTENAL	FASTENAL 1/4 X 20 FLANGE LOCK NUT
	FAST.25X5/8 FLAT	71013	FASTENAL	FASTENAL 1/4 X 5/8 FLAT WASHER
	FAST16X1.25FEN	0172789	FASTENAL	FASTENAL 5/16 X 1.25 FENDER WASHER
	FAST16X7/8FLAT	1171016	FASTENAL	FASTENAL 5.16 X 7/8 FLAT WASHER
	SPA/BALLVALVE	401-0144C	VALTERRA	HIGH FLOW BALL VALVE 401-0144C
	SPA/TOWERGFCORD	30338136-03	TOWER MANUFACTURING	IN LINE ANGLE GFI W/ 15 FT 14/3 SJTW
	SPA/ACCESSPNL	ACCESS PNL	NORCEN INDUSTRIES	BTM COVER PNL .040 X 13-7/8 X 22 TYP
	SPA/ROYAL1-3/8LOCK	DC935-A-751-EL	ROYAL LOCK	1 3/8 " CAM LOCK
	SPA/ROYAL1-1/8LOCK	DC928-A-751-EL	ROYAL LOCK	1 1/8" CAM LOCK #DC928-A W/ 2" CAM
	SPA/RCHC-17STZD	DW-17STZD	ROTOCLIP	SINGLE WIRE STEEL HOSE CLAMP ZINC 3/
	SPA/RCHC-9STZD	HC-9STZD	ROTOCLIP	SINGLE WIRE STEEL HOSE CLAMP / ZINC

Product Registration

It is important that you register your product as soon as possible.

IMPORTANT: Durasport™ Spas Warranty is void if the spa is moved to any location that is not the original 'Ship To' address.

Locating the product serial number

The serial number of your spa is located on a metal plate attached to exterior of the spa. You will need this number to properly register your spa and activate coverage.

Write this information in the space provided below.

FOR YOUR RECORDS:

Spa Model: _____

Spa Serial Number: _____

Date Purchased: _____

Date Installed: _____

Dealer's Phone Number: _____

Dealer's Address: _____

PLEASE FILL OUT SECTION BELOW AND RETURN WITHIN 30 DAYS OF DELIVERY

Place in an envelope and mail to:

Durasport Spas, PO Box 108, Northumberland, PA 17857 USA

•
**or REGISTER YOUR SPA ONLINE AT www.durasportspas.com
Under the CONTACT tab select REGISTER YOUR SPA.**

Purchaser's Name: _____ Delivery Date _____

Address _____

City _____ State _____ ZIP _____

Telephone _____

Signature _____

Spa Model: _____

Spa Serial Number: _____

Dealer/Vendor Name _____ Dealer's Phone _____

Dealer's Address: _____



For customer service, please contact your authorized dealer immediately.

If you need additional information or assistance, call **1-800-787-6649** or email us at **support@strongspas.com**

Durasport™ Spas
3204 Point Township Drive,
Northumberland, PA 17857 USA

READ AND FOLLOW ALL INSTRUCTIONS

To reduce the risk of injury, do not permit children to use this product unless they are closely supervised at all times.

SAVE THESE INSTRUCTIONS

